



Model 80 a 100



Model 120



Model 80 a 100

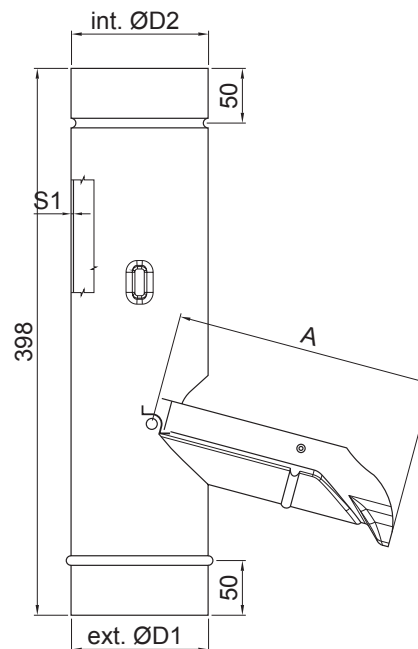



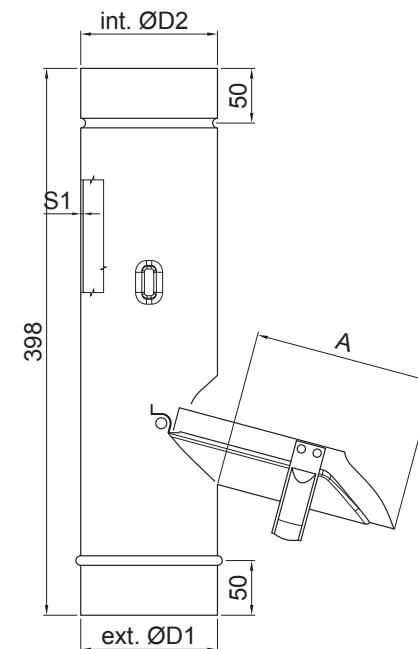







Model 120









Menovité rozmery (mm)	80	100	120
S1	0,70	0,70	0,70
A	150	190	230
ØD1	80	100	120
ØD2	80	100	120

Pre presné spojenie a kompatibilitu s existujúcimi žľabmi, zvodovými rúrami a príslušenstvom, je potrebné, aby boli dodržané rozmery podľa údajov STN EN 612.

Menovitý rozmer (mm)		80	100	120
 Model 80 a 100  Model 120 	AN	8584074035073	8584074035080	8584074035097
	TM	8584074035103	8584074035110	8584074035127
	SS	–	–	–
	ZH	8584074035134	8584074035141	8584074035158
	BH	–	–	–
	MH	–	–	–
	IC	–	–	–
	OC	–	–	–
	MZ	–	–	–
	B	–	–	–
	ZS	–	–	–
	HM	–	–	–
	OZ	–	–	–
	BHT	–	–	–
 Balenie kartón		 / 8 ks	 / 5 ks	 / 3 ks
 Balenie paleta		 / 240 ks	 / 150 ks	 / 90 ks

KJG DESIGN – Hliníkové zachytávače vody

 3D – náhľad	 Produktový prospekt web
 Technický list o produkte	 Objednávkové číslo
 Montážny list	 Balenie

KVALITA MATERIÁLU A POVRCHOVÁ ÚPRAVA:

- EN AW–1050A H24, S1=0,70mm
- Práškový lak, séria 29, fasádne použitie na báze polyesteru, vysoká odolnosť voči poveternostným vplyvom a veľmi dobré mechanické vlastnosti, stupeň lesku ISO 28/13 – 60°, neplatí pre metalické efekty